

Power Wheel® Service Manual Model 110CD (M6-M17 Motors) Double Reduction Wheel Drives

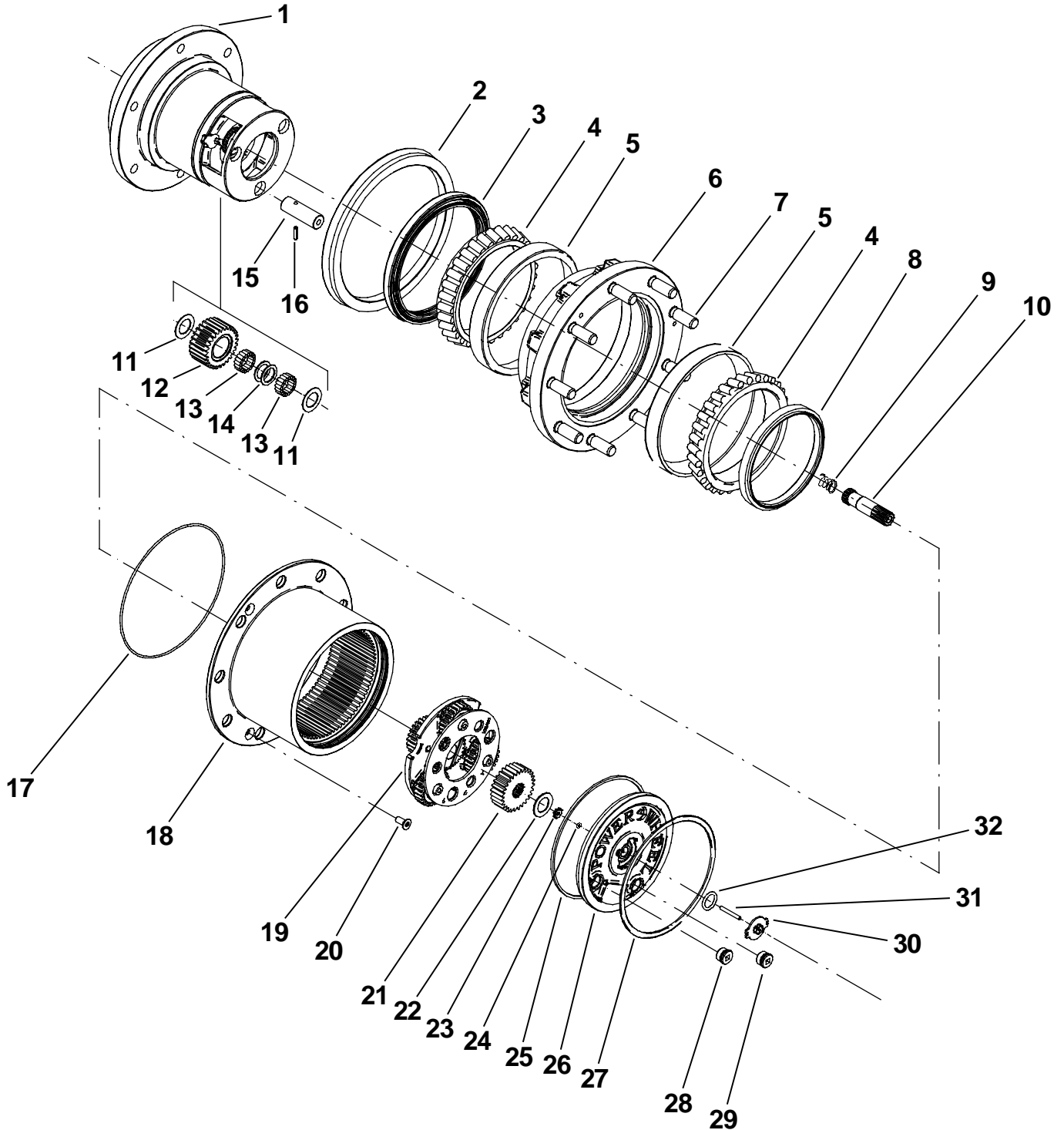

PHONE:(260) 925-3200
FAX:(260) 925-4725
WWW.AUBURNGEAR.COM



IDENTIFICATION

IMPORTANT: All Power Wheel units and kits are shipped with a label that includes the Auburn Gear part number, order code and work order.

Example:

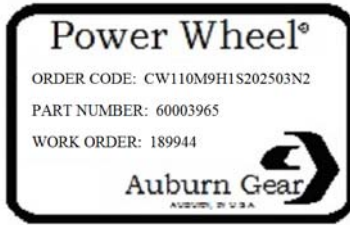

In addition to the label, Power Wheel drives are stamped with the last four digits of the part number and date code, which appears on the cover or hub flange as shown.

Example: **3965 12236**

When ordering parts, the information included on the label or the stamped part number is necessary to accurately identify the drive and obtain the correct replacement parts. Once this information has been obtained, contact Auburn Gear for the appropriate parts list.

DISASSEMBLY OF POWER WHEEL

STEP 1

Position unit vertical onto face of spindle assembly (1). Remove two plugs (28) and (29).

STEP 2

Remove retaining ring (27).

STEP 3

Remove cover (26) by installing 3/4"-16 bolt as shown. Turn bolt until cover (26) lifts off. NOTE: thrust washers (22) and (23), dowel pin (31), 'O'-rings (24) and (32) and disconnect cover (30) generally remain in cover.



STEP 4

Remove primary sun gear (21).

STEP 5

Remove primary carrier assembly (19).

STEP 6

Remove input shaft (10).

STEP 7

Remove disconnect spring (9) if unit is so equipped.

STEP 8

Remove three Torx screws (20) from flange of ring gear (18).

STEP 9

Remove ring gear (18) and 'O'-ring (17).

STEP 10

Rotate hub (6) to allow access to slotted spring pin (16) - as shown.

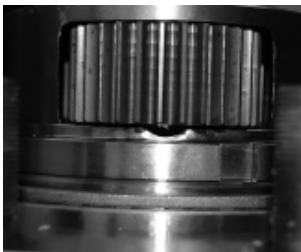

STEP 11

Using appropriate punch, drive slotted spring pin (16) out of secondary planet pin (15). Repeat procedure for remaining two slotted spring pins (16).

STEP 12

Remove secondary planet pin (15) from only one secondary planet gear (12) using 3/8"-16 bolt, make-shift slide hammer - as shown.



STEP 13

While supporting bottom thrust washer (11), carefully remove secondary planet gear and bearing assembly (items 11, 12, 13, 14, 13, 11). Keep this planet gear and bearing assembly intact.

STEP 14

Repeat steps 12 and 13 for remaining two secondary planet gears (12).

STEP 15

Using rotary cut-off tool with fiber wheel, cut pairs of slots into bearing nut (8) at each spindle slot - as shown. NOTE: Take care not to damage adjacent components.



STEP 16

Using appropriate punch, drive the crimped portions of the bearing nut (8) outward - as shown.

**STEP 17**

Unscrew bearing nut (8) with Tool 613G.

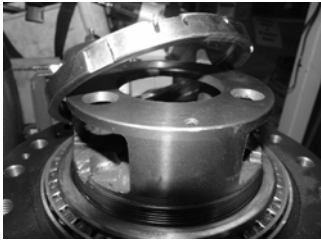
**STEP 18**

Turn unit over, placing it vertically onto face of secondary carrier, [which is part of spindle assembly (1)].

STEP 19

Install three 5/8" bolts into spindle assembly (1) holes at equal spacing - as shown. Make sure hub (6) ribs align with the three bolts. Alternate turning the three bolts until spindle assembly (1) can be easily lifted out of hub (6).

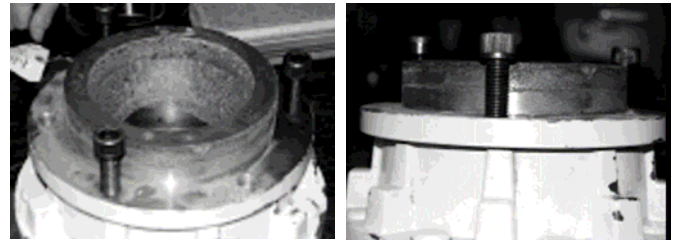
**STEP 20**

Using pry-bar, remove oil seal (3) from hub (6).

STEP 21

Remove bearing cups (5) from hub (6).

ASSEMBLY OF POWER WHEEL

STEP 1

Install bearing cup (5) into the 'Seal' side of hub (6) with Tool 613F.

STEP 2

Install bearing cone (4) into bearing cup (5) installed in Step 1.

STEP 3

Install seal (3) into hub with Tool 613H.

STEP 4

Install opposite bearing cup (5) into hub (6) with Tool 613F.

STEP 5

Install boot seal (2) onto hub (6) if applicable.

STEP 6

Place hub/bearing/seal assembly onto spindle (1).

STEP 7

Install bearing cone (4) onto spindle assembly and press into position with Tool 613FF.

STEP 8

Install bearing nut (8) onto spindle assembly (1).

STEP 9

Tighten bearing nut (8) to 50 lb*ft with Tool 613G.

STEP 10

Rotate hub several revolutions in each direction to allow bearings to seat.

STEP 11

Using an appropriate pick, check each roller of the inner bearing cone (4) for looseness.

STEP 12

If all rollers are tight, proceed to Step 15.

STEP 13

With Tool 613G placed on bearing nut (8), tap end of Tool 613G with an appropriate hammer to advance the inner bearing cone (4) further onto spindle assembly (1).

STEP 14

Repeat Steps 9 thru 13 until all inner bearing cone rollers are tight.

STEP 15

Torque bearing nut (8) to 150 lb*ft with Tool 613G.

STEP 16

Secure bearing nut (8) to spindle assembly (1) by deforming the bearing nut lip into each of the three cast slots in the spindle as shown.

**STEP 17**

Install slotted spring pin (16) into planet pin (15) as shown.

**STEP 18**

Repeat Step 17 for remaining planet pins.

STEP 19

Install planet gear assembly (Items 11-14) into the spindle as shown. (Be sure to align thrust washers and planet gear with the planet pin hole in the spindle assembly (1).)

**STEP 20**

Install planet pin (15) thru the spindle hole and planet gear assembly as shown. Make note of the position of the slotted spring pin and align with the cast slots in the spindle assembly (1).

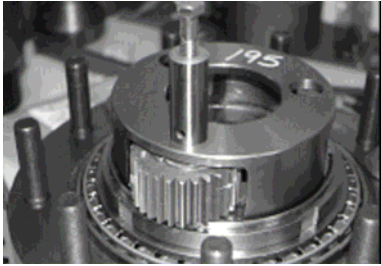
**STEP 21**

Using a suitable drift punch (or Tool 613GG), drive slotted spring pin (16) 1/3 to 1/2 way out of the planet pin (15) and into the cast slot as shown. Verify that the planet pin is retained and that the planet gear rotates freely.

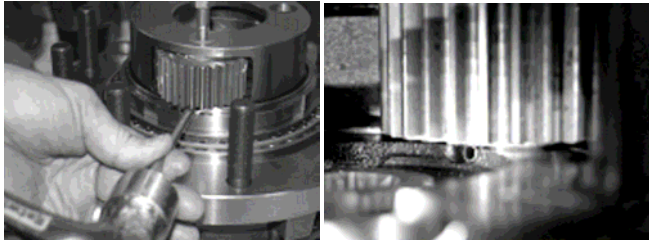
**STEP 22**

Repeat Steps 19 thru 21 for the remaining planet gears.

STEP 23

Install disengage spring (9) and input shaft (10) into spindle assembly (1).

STEP 24

Lubricate and install o-ring (17) onto hub (6).

STEP 25

Install ring gear (18) onto hub (6), aligning the three countersunk holes with the three threaded holes. It may be necessary to rotate the planet gear (12) into alignment with the ring gear teeth.

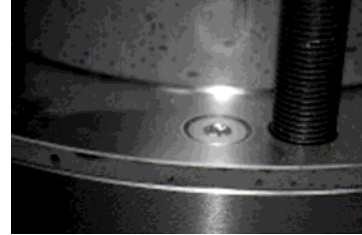
**STEP 27**

Install primary carrier assembly (19). It may be necessary to align gear teeth during installation.

STEP 28

Install primary sun gear (21) with internal spline down against the secondary sun gear as shown.

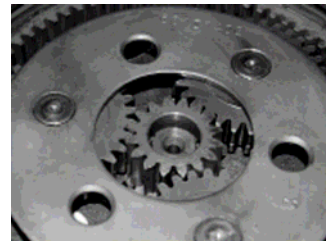
**STEP 29**

Lubricate and install o-ring (25) into groove inside ring gear (18).

STEP 30

Install cover (26), (with Items 23, 24, 30, 31, & 32 in place), onto ring gear (18). Snap ring groove will be visible when cover is properly positioned.

STEP 31

Install spiral retaining ring (27) into outer ring gear groove.

STEP 32

Fill to proper level with EP gear oil.

STEP 33

Install port plugs (28 and 29) and torque to 6-10 lb*ft.

DO NOT OVERTIGHTEN

NOTE: When installing a hydraulic motor to the Power Wheel drive it is necessary to place an "O" ring or gasket (not supplied by Auburn Gear) between the motor and the planetary drive.

Cartridge style motor "O" ring size: 2-159

SAE motor "O" ring sizes: SAE A 2-042, SAE B 2-155, SAE C 2-159, SAE D 2-163.

CARRIER ASSEMBLIES

It is recommended that the primary carrier assembly (19) be serviced in its' entirety to protect the integrity of the Power Wheel drive.

LUBRICATION RECOMMENDATIONS

IMPORTANT: POWER WHEEL PLANETARY DRIVES ARE SHIPPED WITHOUT LUBRICANT AND MUST BE FILLED TO THE PROPER LEVEL PRIOR TO START UP.

Observe lubrication recommendations given by the original equipment manufacturer. When specific recommendations are not available, use mild extreme pressure lubricant API-GL-5, No. 80 or 90 when filling the Power Wheel under normal temperature ranges between 0 to 120°F (-18 to 49°C). Power Wheel is to be half full of oil when unit is mounted level and horizontal. Use drain and fill plugs (28 & 29) located in cover (26). Oil is to be changed after first 50 hours of operation with subsequent changes every 1000 hours or yearly, which ever occurs first. If unit is to be operated vertically, if ambient conditions are outside the specified range, or if the oil temperature exceeds 200°F (93°C), contact Auburn Gear for oil and level recommendations.

TOWING VEHICLE

CAUTION: The Power Wheel will not normally be damaged by towing; however, the hydraulic drive components may be damaged unless the Power Wheel is disengaged from the drive motor. Road speeds in excess of 25 MPH should be avoided unless clearly specified to be permissible by the original equipment manufacturer.

TO DISENGAGE POWER WHEEL

CAUTION: For units equipped with standard spring disconnect, assemble the disengage cover (30) with the dimpled center protruding inward.

STORAGE

A protective film is applied to the Power Wheel at the factory to prevent rust during shipment. Additional protection may be required if the Power Wheel is to be stored for an extended period of time.

SPECIFICATIONS

Maximum intermittent output torque 110,000 lb-in (12,430 N-m)
Maximum input speed W/O Park Brake: 5,000 RPM With Park Brake: 3,600 RPM
Oil capacity Double Reduction: 33 oz (976 cc)

ITEM NO.	DESCRIPTION*	NO. USED IN ASS'Y.	ITEM NO.	DESCRIPTION*	NO. USED IN ASS'Y.
1	Spindle Assembly	1	17	'O' - Ring	1
2 ***	Boot Seal	1	18	Ring Gear	1
3	Oil Seal	1	19	Primary Carrier Assembly	1
4	Bearing Cone	2	20	Torx Screw	3
5	Bearing Cup	2	21	Primary Sun Gear	1
6	Hub	1	22	Thrust Washer	1
7 ***	Wheel Bolt	varies	23	Thrust Washer	1
8	Bearing Nut	1	24	'O' - Ring	1
9	Disengage Spring	1	25	'O' - Ring	1
10	Input Shaft	1	26	Cover	1
11	Thrust Washer	6	27	Retaining Ring	1
12	Secondary Planet Gear	3	28	Port Plug	1
13	Roller Bearings	102	29	Port Plug	1
14	Separator	6	30	Disengage Cover	1
15	Secondary Planet Pin	3	31	Dowel Pin	1
16	Slotted Spring Pin	3	32	'O' - Ring	1

* Contact Auburn Gear with part number and order code of the PW assembly to obtain the appropriate parts list. Refer to parts list for the specific part numbers and quantities.

*** Not required in all assemblies

Model 110CD Power Wheel® Service Kits

Part No.	Description	Included Items
613F	Cup Driver	Not Shown
613FF	Cone Driver	Not Shown
613G	Nut Driver	Not Shown
613GG	Pin Driver	Not Shown
613H	Seal Driver	Not Shown
641092	Bearing & Seal Kit	3, 4 (qty 2), 5 (qty 2), 8
641091	Seal Kit	3, 8

Power Wheel ® is a registered trademark of Auburn Gear